

Portões



Sistema de Portões

O sistema de portões de jardim POR, permite criar portões de correr e batente de uma e duas folhas. Na opção de batente, os portões possibilitam a aplicação um aro fixo, permitindo assim uma maior vedação visual.

A vasta gama de perfis que incorporam o portfólio desta série, permitem criar inúmeras tipologias, com várias possibilidades de enchimento.

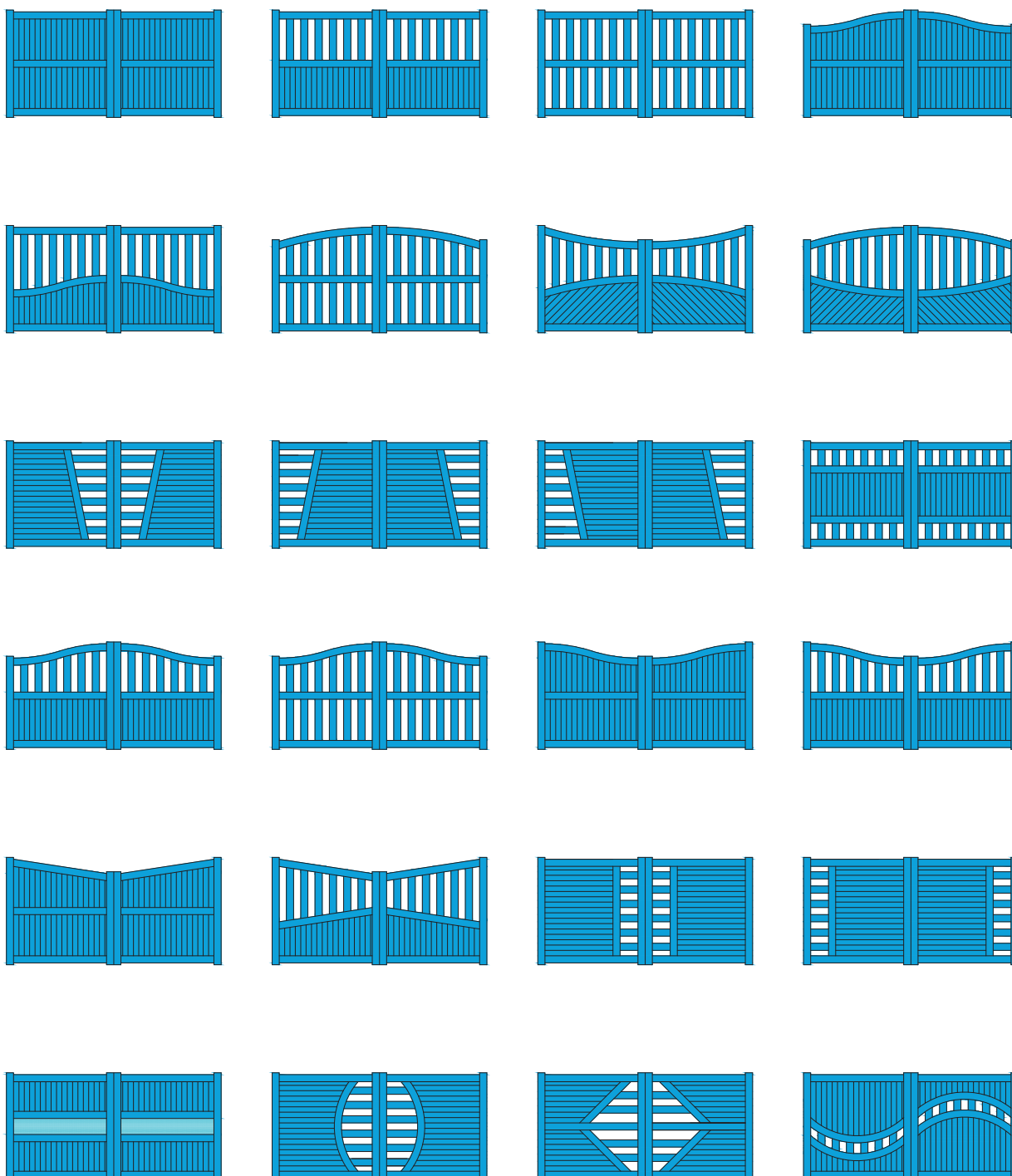

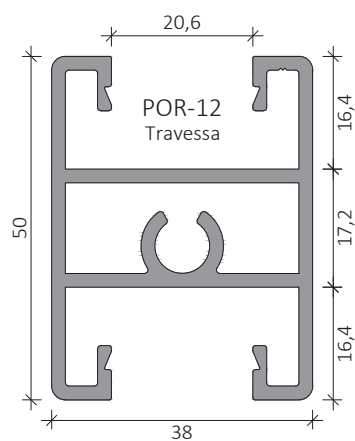
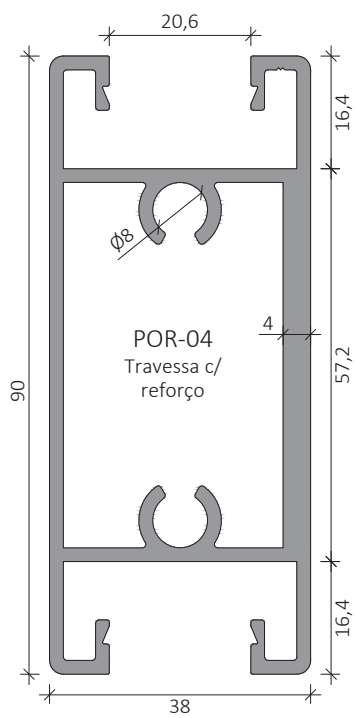
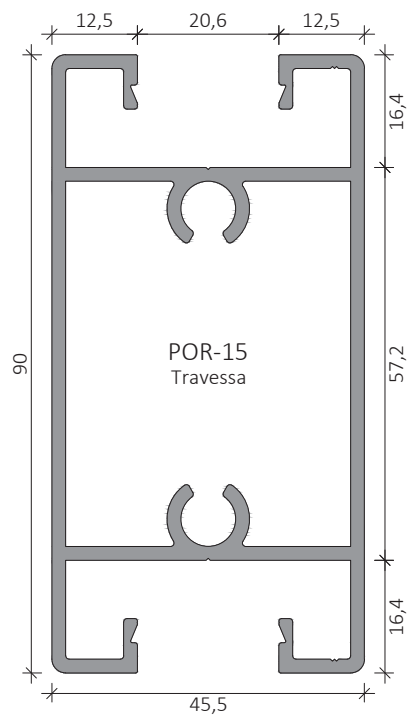
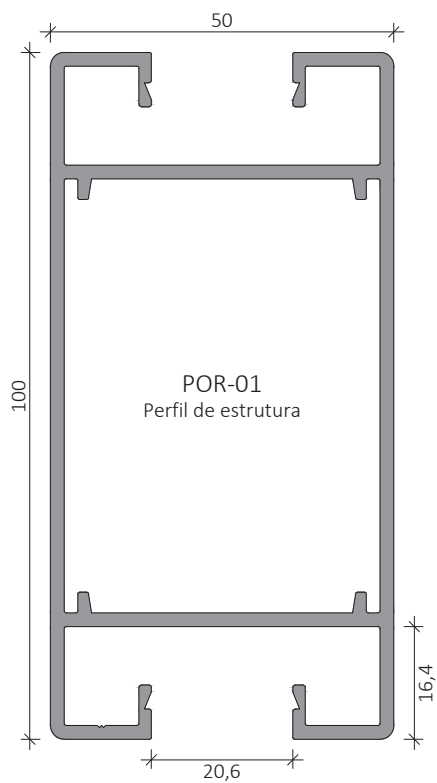

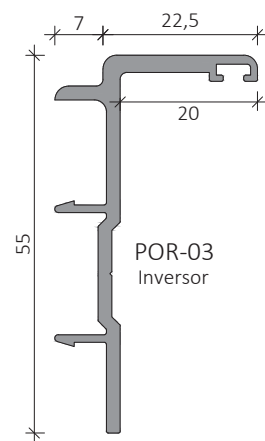
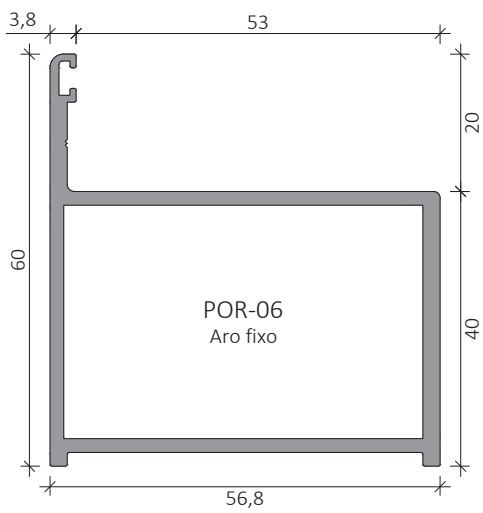
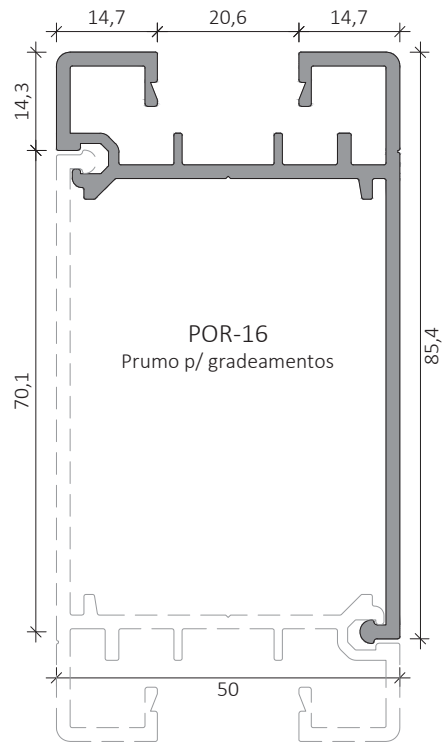
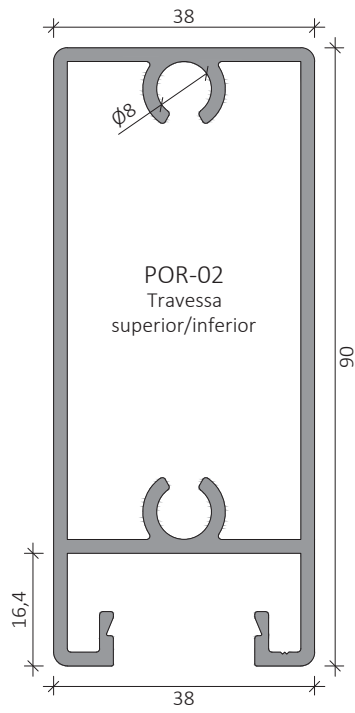

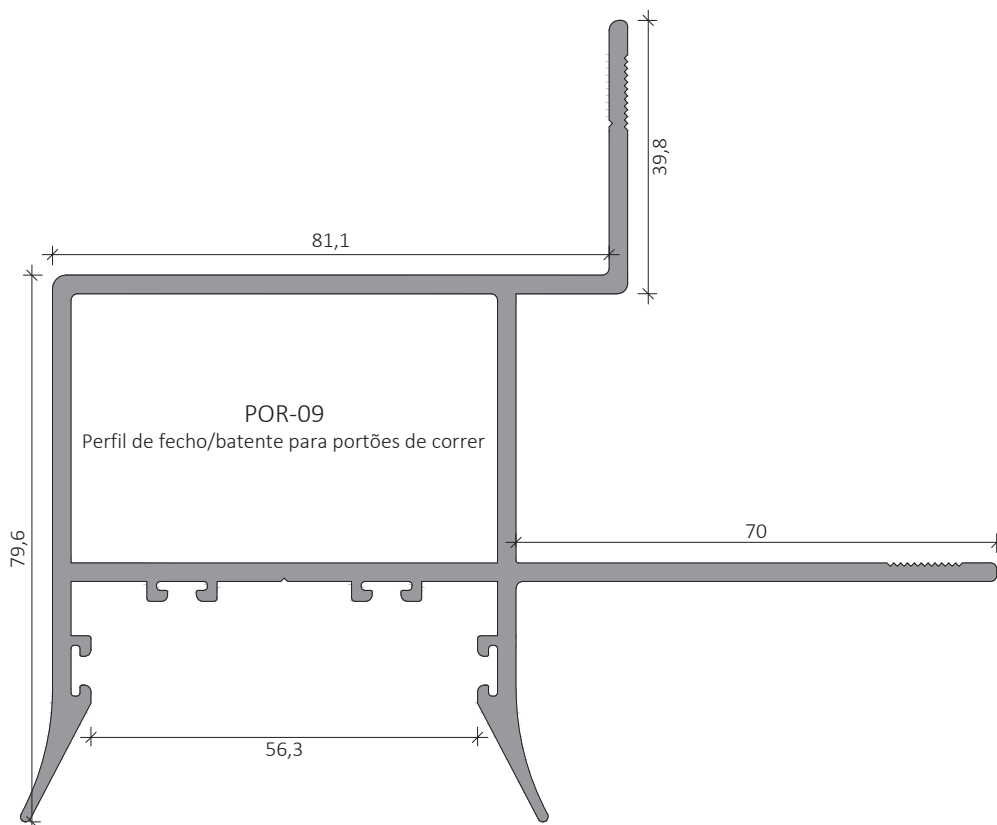
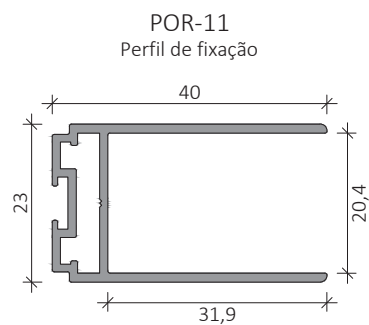
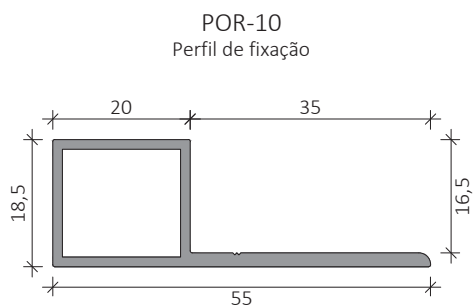
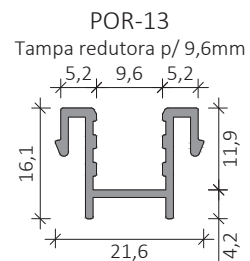
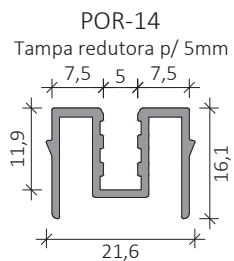
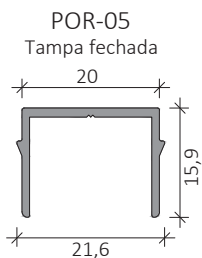

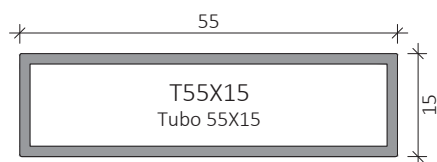
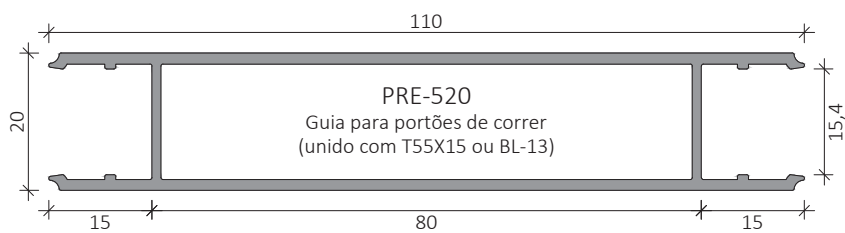
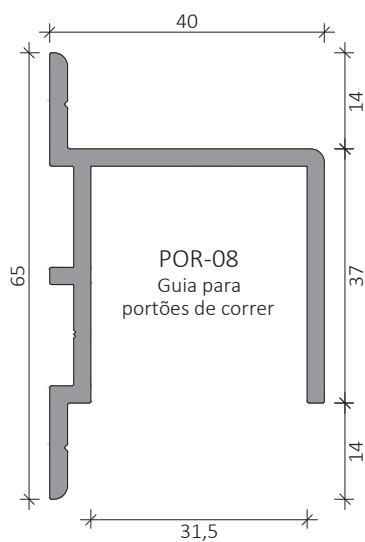

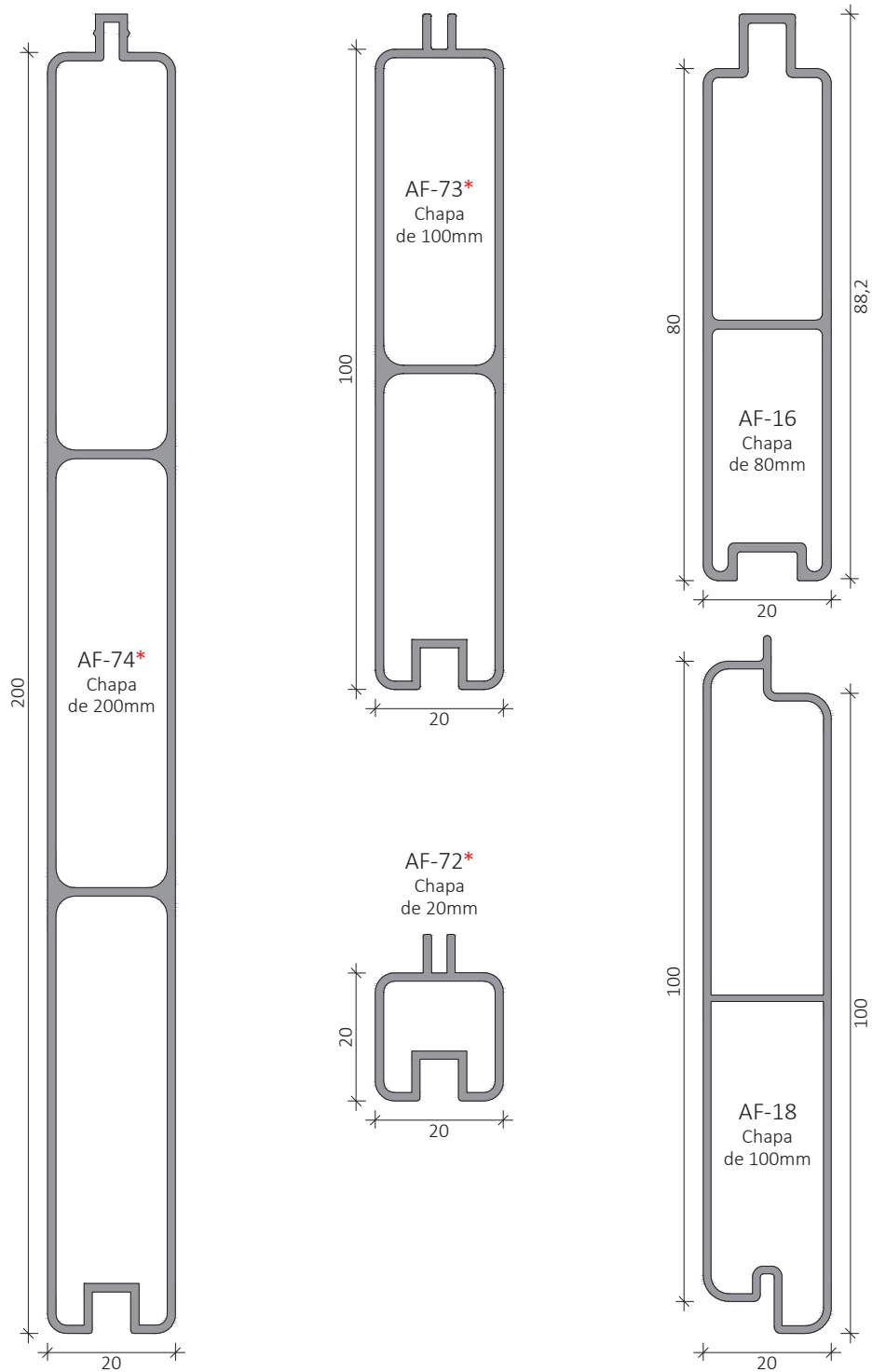



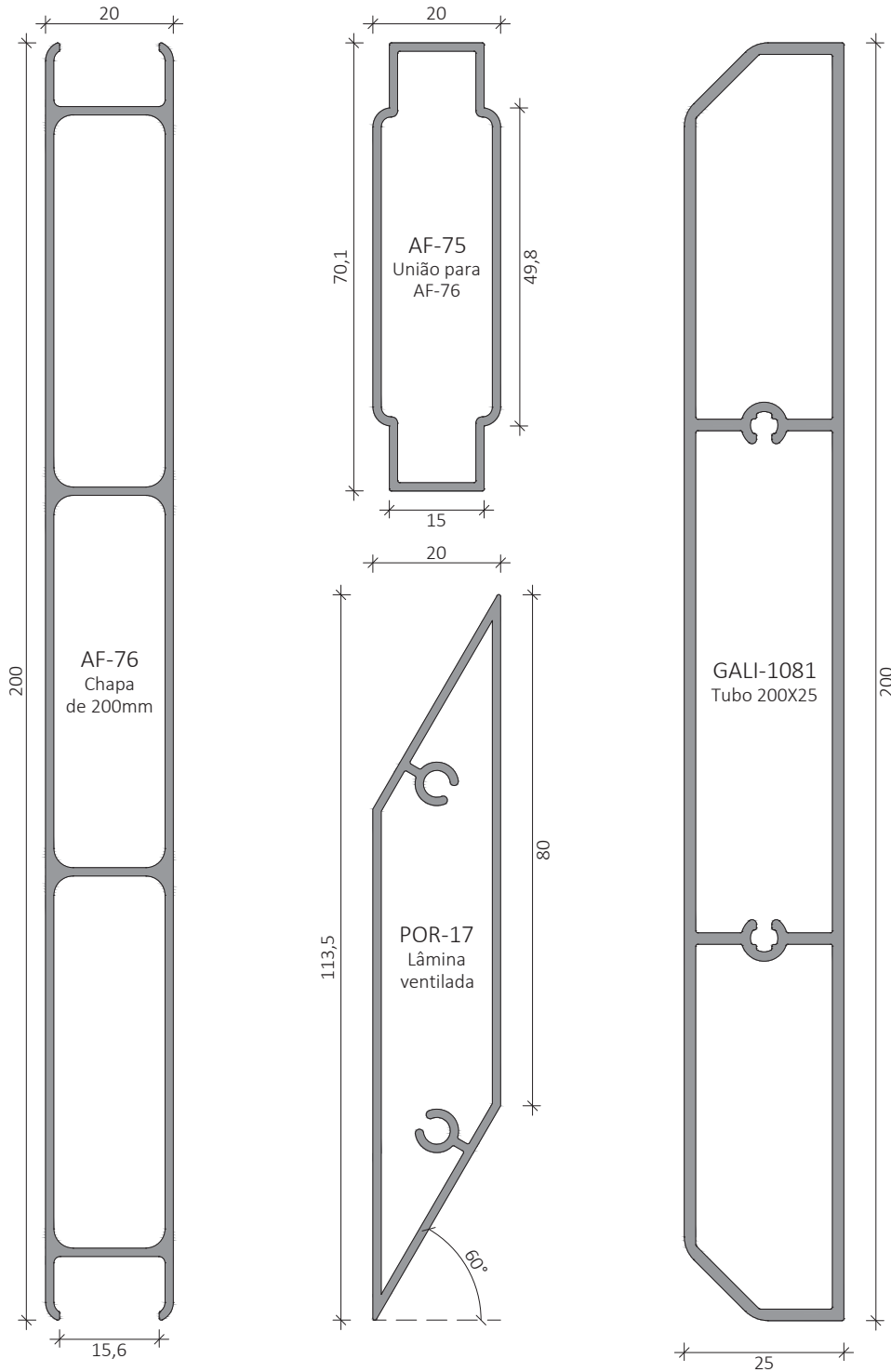

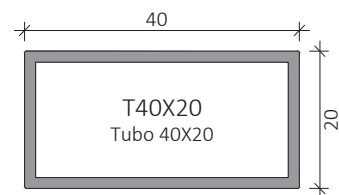
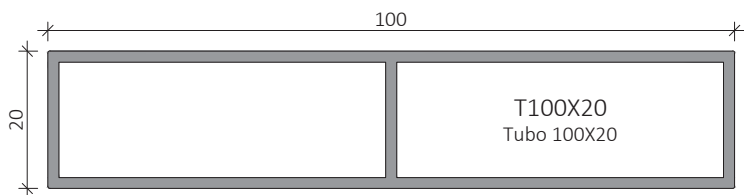
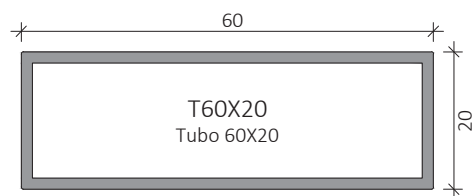
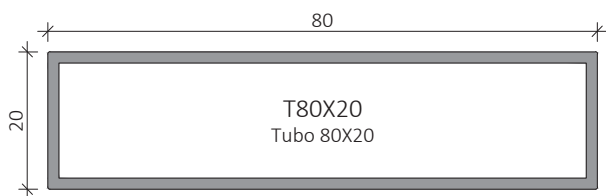
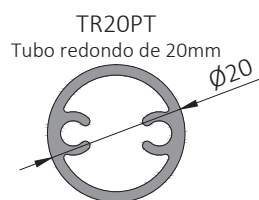
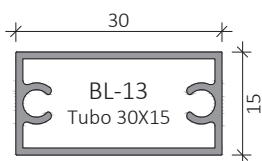
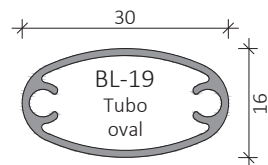
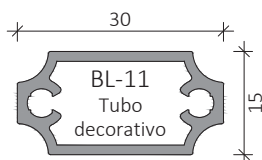
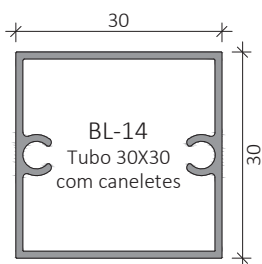
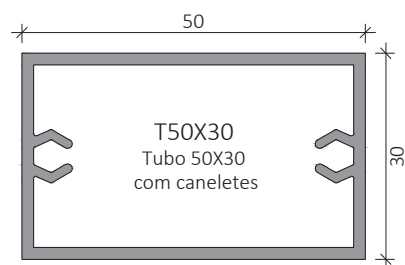
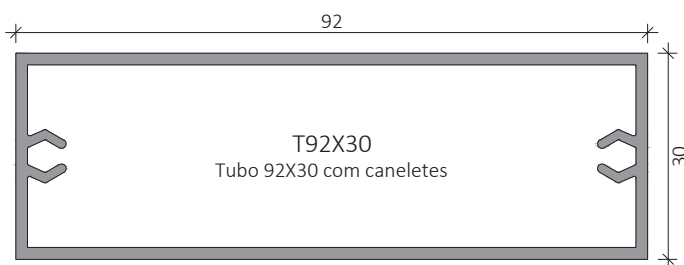

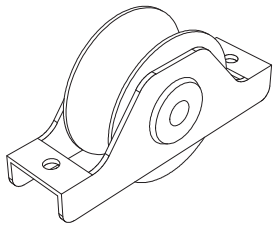
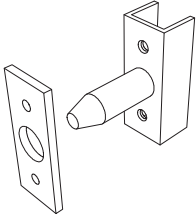
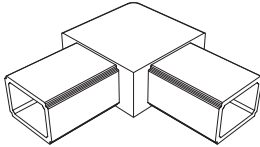
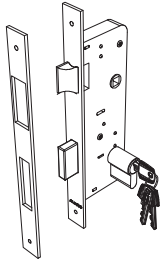
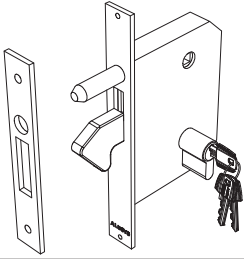
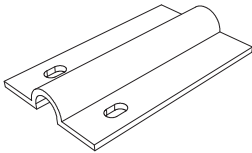
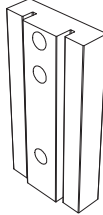

* Chapas com encaixe compatível entre si.

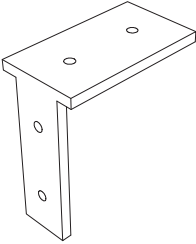

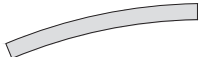
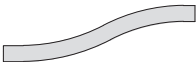

<p>POR1006 Topo para perfil POR-01 POR-16</p> 	<p>POR1009 Topo para perfil POR-01 - receptor de pivo</p> 	<p>POR1007A Sapata para perfil POR-01 POR-16</p> 	<p>POR1010 Topo para perfil POR-06 (Par)</p> 
<p>POR1015 Topo para POR-09</p> 	<p>POR1003 Batente para portões de uma folha</p> 	<p>POR1001 Batente para portões de duas folhas com motor</p> 	<p>POR1002 Batente para portões de duas folhas com fecho de segunda folha</p> 
<p>POR5008/16P Tampa para parafusos</p> 	<p>POR1014 Batente para portões de correr</p> 	<p>POR1021 Pivo superior</p> 	<p>POR1023 Casquilho superior regulável</p> 
<p>POR1020 Tampa para POR-PIVO2</p> 	<p>POR1022 Pivo inferior</p> 	<p>POR1024 Casquilho inferior regulável</p> 	<p>POR1005 Kit de dobradiça pivotante</p> 
<p>DOB1008 Dobradiça para portões - POR-06/POR-01</p> 	<p>DOB1010 Dobradiça tripla para portões - POR-01/POR-01</p> 	<p>POR1008 Guia para portões de correr</p> 	<p>POR-DIN9X4.65 Parafuso para perfis de portões</p> 

<p>POR1004 Rolamento galvanizado para portões de correr</p> 	<p>POR1026 Espigão para portões de correr</p> 	<p>PORESQ01 Esquadro exterior para POR-01</p> 	<p>POR1011 Fechadura para portões de batente</p> 
<p>POR1016 Fechadura para portões de correr</p> 	<p>POR1012 Carril para de aparafusar (3m)</p> 	<p>POR1019A Calço de preenchimento POR-01</p> 	<p>POR1019 União para travessas</p> 
<p>POR1018 União para travessas</p> 	<p>PORMODELO01</p> 	<p>PORMODELO02</p> 	<p>PORMODELO03E</p> 
<p>PORMODELO04E</p> 	<p>PORMODELO05</p> 	<p>PORMODELO06</p> 	<p>PORMODELO07E</p> 
<p>PORMODELO08E</p> 